

2665.692.8

ABS trapped floor drain for built-in shower

DESCRIZIONE DEL PRODOTTO

[vc_row][vc_column][vc_column_text css=""]

1. frame 150×150
2. tileable cover 130×130
3. AISI316 stainless steel cover and frame adjustable in height and orientable relative to the outlet direction
4. with anti-infiltrations flange useful for waterproofing
5. without waterproofing sheet
6. water trap removable for maintenance
7. dry-spot, drainage point for the water filtered through the flooring
8. ABS lateral outlet DN50
9. tiling thickness 25÷40
10. under floor encumbrance 60

[/vc_column_text][/vc_column][/vc_row]

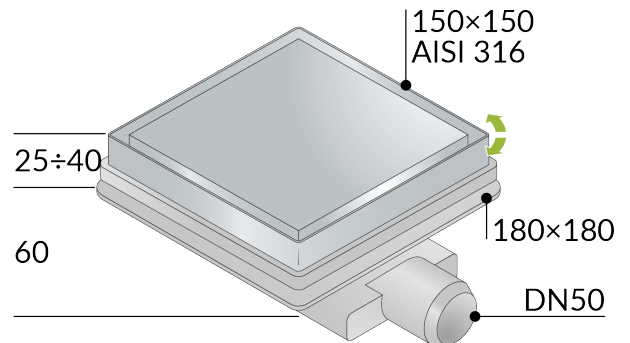

Name	Tirana
Measure	150×150×DN50
Water seal	30
Water volume	31

PHOTO GALLERY

