

2755.502.8

ABS trapped floor drain for built-in shower

DESCRIZIONE DEL PRODOTTO

[vc_row][vc_column][vc_column_text css=""]

1. frame 115×115
2. tileable cover 100×100
3. AISI316 stainless steel cover and frame adjustable in height and orientable relative to the outlet direction
4. perimetric waterproofing
5. dry trap removable for maintenance
6. EPS base for the trap housing and the soundproofing
7. protection lid for construction site
8. dry-spot, drainage point for the water filtered through the flooring
9. ABS lateral outlet DN50
10. tiling thickness 25÷40
11. under floor encumbrance 60

[/vc_column_text][/vc_column][/vc_row]

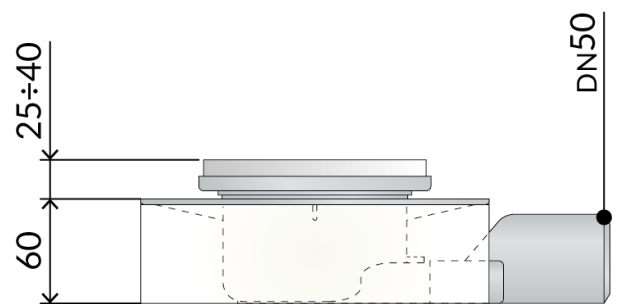
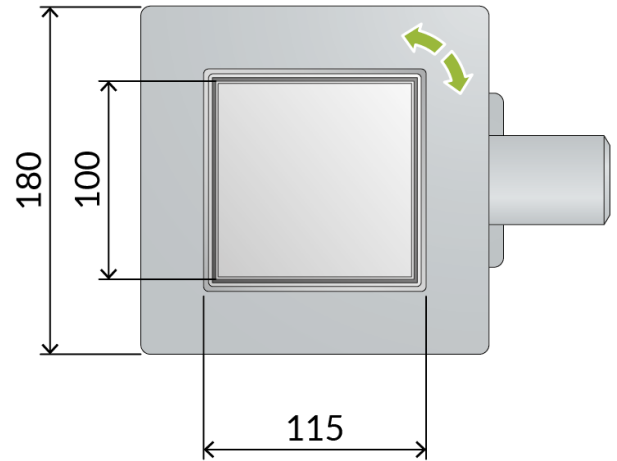

Name	Tirana evo dry trap
Misura-HM	60
Misura-HT	25÷40
Water volume	22
Measure	115×115×DN50

PHOTO GALLERY

