

322.222.5

Chrome plated brass trap

DESCRIZIONE DEL PRODOTTO

1. inlet H. 75 × 1"¼
2. outlet L. 250 × ø32
3. s/steel flange ø75

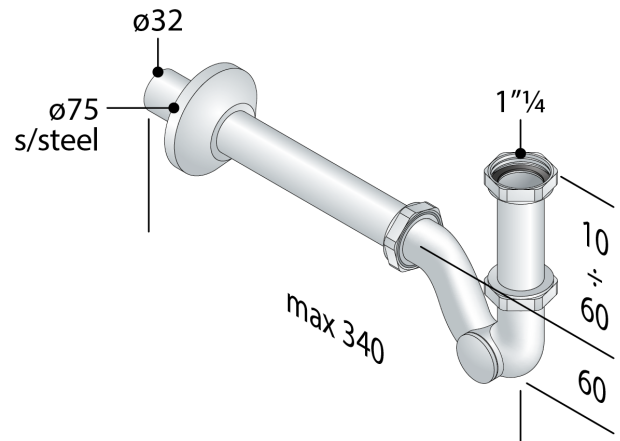

Measure 1"¼ × ø32

Name Europa

Water volume 44

Water seal 25



OMP S.p.A.

Via XI Febbraio 18
I-25065 Lumezzane - Italy
VAT No: IT 00628500985

Office and delivery service

Via Industriale, 14 - I-25070 Bione - Italy
+39 0365 897941

omptea.eu - info@omptea.com



PHOTO GALLERY

